

# SGLOCKS

## Newsletter

APR / MAY 2026  
ISSUE 127



**NEW**

**BURG WACHTER  
PROFI-SAFE RANGE**



**NEW**

**LOCKFEST '26  
LOCKSMITH  
ROADSHOW WRAP-UP**





# Profi-Safe

CERTIFIED PROTECTION



**NEW**



# Profi-Safe

CERTIFIED PROTECTION



*“Proven When it Matters”*





**- Certified Protection  
Proven When it Matters**



**INSURABLE RATING**  
Recommended up to  
**\$35,000**



**Security Level S2**  
Certified protection against burglary



**FIRE RESISTANCE GRADE LFS 30**  
Certified protection against fire



## **- High-Security Burglary and Fire**

*Certified by the ECB.S and recognised in Australia and New Zealand as the benchmark, combined with clean contemporary design for premium home and office environments.*

**SEE OVER for More  
Info on ECB.S**







# Profi-Safe

CERTIFIED PROTECTION



## ECB•S Certification - Key Features & Benefits

### Independent Certification

- Certified by a neutral and **independent certification authority**
- Accredited to **ISO/IEC 17065** for product certification



## - Security Proven, Not Promised

### Independent, Real-World Certified Security



- Safes are **physically attacked and tested** under controlled conditions
- Testing **simulates real burglary methods, tools, and applied force**
- Certification is based on **actual resistance, not theoretical or design claims**
- Results are assigned a **clearly defined security grade (e.g. Grade I, II, III)**
- The grade defines the **proven security level** of the safe
- This **removes ambiguity** when **specifying, comparing, or selecting safes**





## - Insurer Recognition & Acceptance

- ECB•S certified safes are **widely recognised by insurers**
- Used as a **reliable basis for risk assessment and insurance grading**
- Often **required or recommended** for insured valuables
- ECB.S Certification requires **ongoing surveillance and audits**
- Ensures safes continue to be manufactured to the **certified standard**
- Prevents “one-off test” certification shortcuts



## - ECB•S Certified Fire Protection

- Safes are **fire-tested under controlled laboratory conditions** in accordance with **fire-resistance standards**
- Testing verifies the safe's ability to **protect paper documents** from heat exposure for a **defined time period**
- Certification is based on **measured internal temperature performance**, not construction claims alone
- Provides **independently verified fire protection**, recognised and trusted



## - Official ECB•S Certification Plate

- Certified safes carry an **official ECB•S type plate**
- Plate identifies:
  - Certificate number
  - Resistance grade
  - Year of manufacture
  - Tested standards
- Provides **instant verification and traceability**







## - Premium workmanship

- *Double-walled construction for enhanced strength and durability*
- *Solid round bolt locking system for secure door engagement*
- *Internal hinges for added protection and a clean exterior appearance*
- *Rear grip rail on the hinge side for additional structural stability*

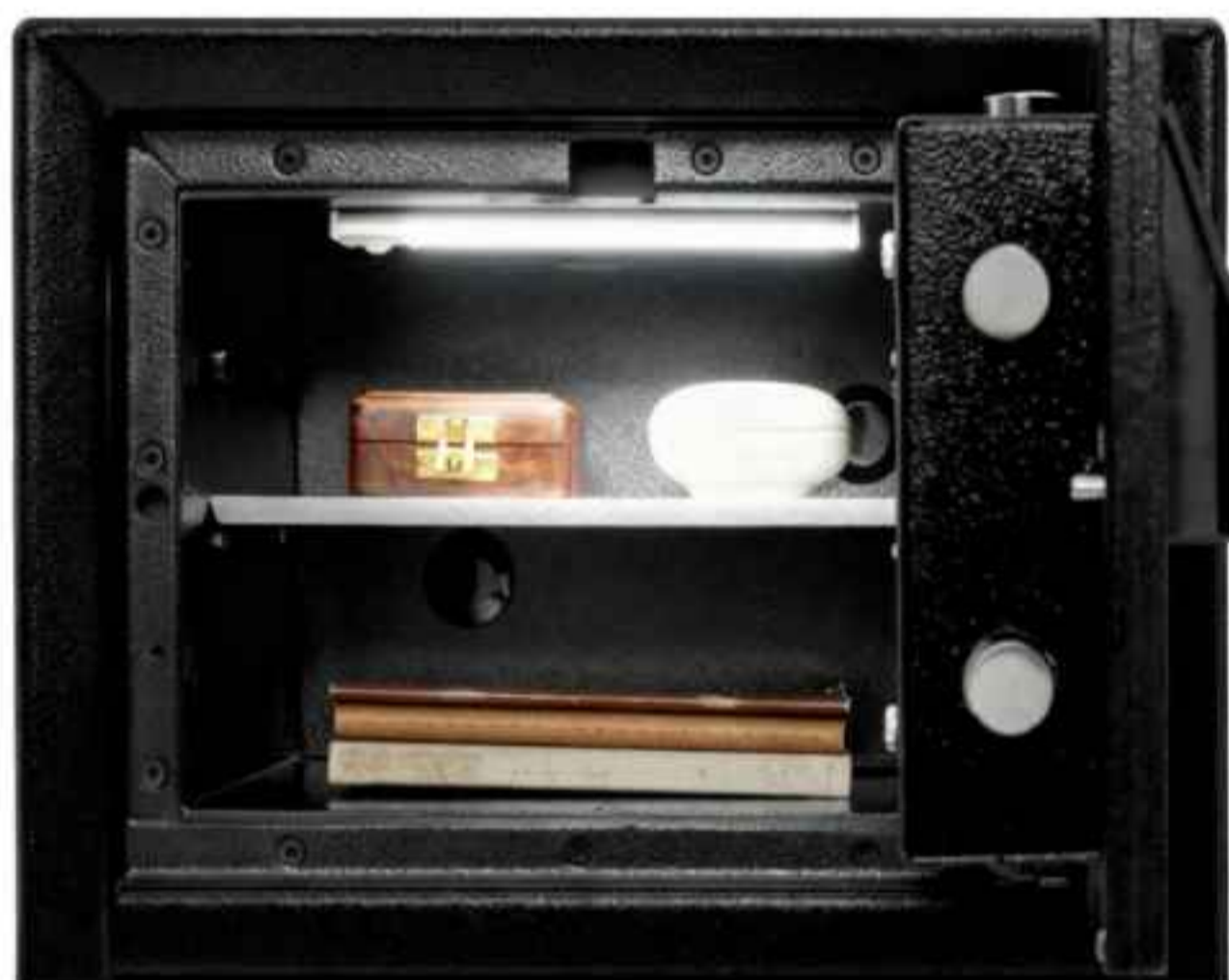

## - Integrated interior lighting

- *Built-in LED lighting for clear visibility*
- *Ensures easy access and organisation of contents inside the safe*

## - Elegant design, convenient opening

- *Electronic combination lock with intuitive, user-friendly operation*
- *Illuminated touch control panel with a clear graphic display*
- *Two individually programmable 6-digit codes (administrator and user)*
- *Up to 1,000,000 possible code combinations for enhanced security*







# Profi-Safe

CERTIFIED PROTECTION

## PRODUCT DESCRIPTION:

- The BURG-WÄCHTER Profi-Safe range of Safe Cabinets are both Security & Fire Certified. They are ideal for the safe storage of documents, cash, jewellery, coins and valuables.
- New Safe Body Design w/ Metal Turn Handle
- Security Level S 2 according to DIN EN 14450
- Insurance Rating \$35,000 approx.
- Fire Resistance LFS 30 according to EN15659 - 30 minutes fire protection for paper
- Fire-protective material according to DIN 4102
- Composite insulation in front of the door leaf as heat protection for the lock and bolts
- Tested and certified protection against burglary and fire
- Double-walled construction
- Internal hinge
- Lateral locking through strong round bolts of 25mm plus sliding bolt on the top
- All-over gripping rail on the hinge side
- Prepared for both wall and floor fixing, with fixing material - extreme high breaking strength
- Colour: Black
- Standard series with 1 shelf each
- Fixing hole diameter to suit up to 10mm bolt
- Interior Motion Sensing LED included
- **SecuTronic - Code lock with EBS Certification**
- Updated and Enhanced Codepad design
- ECB-S certified safe lock according to EN 1300 Class A
- Programmable electronic combination lock
- Up to 6 Digit Admin & User Codes (1 of each)
- Audit Trail shows time and date that User 1 has opened safe
- 1,000,000 different codes possible Version E "SecuTronic"



Art ID. PRS510-E

- Exterior Size (H x W x D): 320 x 435 x 380mm (not including key pad)
- Key pad protrudes 15mm & handle protrudes 63mm only when pulled out to open safe
- Interior Size (H x W x D): 205 x 320 x 232mm
- Door Size (H x W): 205 x 265mm
- Weight (KG): 44kg
- Volume(L): 15L
- Warranty: 2 Years - From Date of Sale to End-User (\*)



Art ID. PRS520-E



Art ID. PRS540-E



Art ID. PRS580-E

- Exterior Size (H x W x D): 360 x 495 x 445mm (not including key pad)
- Key pad protrudes 15mm & handle protrudes 63mm only when pulled out to open safe
- Interior Size (H x W x D): 245 x 380 x 297 mm
- Door Size (H x W): 245 x 325mm
- Weight (KG): 55kg
- Volume(L): 27L
- Warranty: 2 Years - From Date of Sale to End-User (\*)

- Exterior Size (H x W x D): 560 x 495 x 445mm (not including key pad)
- Key pad protrudes 15mm & handle protrudes 63mm only when pulled out to open safe
- Interior Size (H x W x D): 445 x 380 x 297mm
- Door Size (H x W): 445 x 325mm
- Weight (KG): 77kg
- Volume(L): 50L
- Warranty: 2 Years - From Date of Sale to End-User (\*)

- Exterior Size (H x W x D): 820 x 495 x 445mm (not including key pad)
- Key pad protrudes 15mm & handle protrudes 63mm only when pulled out to open safe
- Interior Size (H x W x D): 694 x 380 x 297mm
- Door Size (H x W): 694 x 324mm
- Weight (KG): 111kg
- Volume(L): 78L
- Warranty: 2 Years - From Date of Sale to End-User (\*)



**THINK YOUR  
SHOP, VAN, UTE  
HAS WHAT IT TAKES?**



**— 2026 —**



Registrations for - 2026 - **NOW OPEN!**

PROUDLY SPONSORED BY







SYDNEY

MELBOURNE

HOBART

PERTH

ADELAIDE

BRISBANE

AUCKLAND

WELLINGTON

LOCKFEST 2026 — THAT'S A WRAP!  
AUSTRALIA & NEW ZEALAND, COMPLETE.

ACROSS 8 EVENTS, LOCKFEST 2026  
DELIVERED HANDS-ON DEMOS, REAL  
CONVERSATIONS, AND THE FACE-TO-FACE  
CONNECTION THAT MAKES THIS INDUSTRY  
STRONG.

FINAL TALLY:

512 ATTENDANCE | 8 EVENTS | AU & NZ

A HUGE THANK YOU TO EVERYONE WHO  
ATTENDED — YOUR TIME, QUESTIONS,  
FEEDBACK, AND ENERGY ARE WHAT TURNED  
THIS ROADSHOW INTO A GENUINE LOCKFEST

SEE YOU NEXT YEAR!

FINAL  
TALLY

512





# SYDNEY







**RECORD  
ATTENDANCE**

**115**







CBC  
CO

# MELBOURNE



## WEEK 1 VIDEO



WEEK 1  
DONE

ATTENDANCE  
TALLY 230 1:19







**HOBART**







**PERTH**







# ADELAIDE



## WEEK 2 VIDEO



**WEEK 2 DONE**

**230** WEEK 2: **150**

**380** 1:08

**RUNNING TALLY**





# BRISBANE







*Caxton Street*  
BREWING COMPANY

**WEEK 3**  
**VIDEO**



**WEEK 3**  
**DONE**

ATTENDANCE  
TALLY

WEEK 1: 230

WEEK 2: 150 WEEK 3 60



RUNNING  
TALLY

**440**





# AUCKLAND







# WELLINGTON

**GARAGE**  
WELLINGTON  
**PROJECT**



# WEEK 4 VIDEO



**AUCKLAND**  
**WELLINGTON**





# WOLFLOK

Maximum security key lock boxes



Rigorously performance-tested



**SCAN  
TO WATCH**





Art ID. 960064

## 'WOLFLOK' - Maximum Security Key Safe

### PRODUCT DESCRIPTION

The WOLFLOK Art. 960064 is a high-quality, maximum-security mechanical key safe and the world's first and only to achieve the LPS1175 Issue 8 A10 security rating from the Loss Prevention Certification Board.

It features a unique **multi-push keypad** that allows up to four uses of the same button, making memorable codes easier to set while enabling code lengths of up to **40 digits**.

Security is further enhanced by a world-first patented spring-loaded anti-pick mechanism integrated directly into the body of the safe.

Designed for ease of use at any time, the safe includes large, easy-press backlit buttons powered by a patented illumination module for 24-hour visibility, along with an internally illuminated storage compartment.

The external toughened plastic weather cover protects the key safe from the elements and helps extend product lifespan.

The unit has been extensively tested and is rated to last up to **80 years of use**, or approximately **116,800 openings** (based on four uses per day).

Suitable for storing most commercial and domestic keys, as well as access cards and fobs, the key safe can be mounted to timber, metal, or rendered surfaces, achieving maximum security when installed on solid materials such as brick, blockwork, or flat stone (with a recommended 150 mm clearance from the edge).

### PRODUCT SPECIFICATION

- Storage Capacity: 6 Keys
- Possible Code Combinations: Over 9.7 million
- External Dimensions (H x W x D): 150 x 77 x 72mm
- Internal Dimensions (H x W x D): 93 x 58 x 21mm
- Weight: 2.1kg
- Body Material: Zinc Alloy
- Supplied with: 4 x Standard Fixing Screws
- Security Rating: LPS1175 Issue 8 A10
- IP Rating: IP55
- 5 Year Warranty (\*)
- Battery Type: Coin Battery (CR2032)



Art ID. 960071

## 'WOLFLOK' - Maximum Security Key Safe

### PRODUCT DESCRIPTION

The WOLFLOK 'PRO' Art. 960071 is a high-quality mechanical key safe and the world's first and only to achieve the LPS1175 Issue 8 B1 security rating from the Loss Prevention Certification Board.

It features a unique **multi-push keypad** allowing up to four uses of the same button, making memorable codes easier to set while enabling code lengths of up to **40 digits**.

Security is further enhanced by a world-first patented spring-loaded anti-pick mechanism integrated directly into the body of the safe.

Designed for effortless access day or night, the safe includes large, easy-press backlit buttons powered by a patented illumination module for 24-hour visibility, along with an internally illuminated storage compartment.

A toughened plastic weather cover protects the key safe from the elements and helps extend product lifespan. The unit has been extensively tested and is rated to last up to **80 years of use**, or approximately **116,800 openings** (based on four uses per day).

The safe is suitable for storing most commercial and domestic keys, including mortice keys, access cards, and fobs, and can be mounted to timber, metal, or rendered surfaces, achieving maximum security when installed on brick, blockwork, or flat stone (minimum 150 mm from the edge).

The WOLFLOK 'PRO' includes increased physical security through XL security screws, a reinforced stainless-steel internal vault, and additional anti-saw reinforcement pins,

### PRODUCT SPECIFICATION

- Storage Capacity: 6 Keys
- Possible Code Combinations: Over 9.7million
- External Dimensions (H x W x D): 150 x 77 x 72mm
- Internal Dimensions (H x W x D): 93 x 58 x 21mm
- Weight: 2.2kg
- Body Material: Zinc Alloy
- Supplied with: 4 x Standard Fixing Screws & 4 x XL Security Screws
- Security Rating: LPS1175 Issue 8 B1
- IP Rating: IP55
- 5 Year Warranty (\*\*)
- Battery Type: Coin Battery (CR2032)





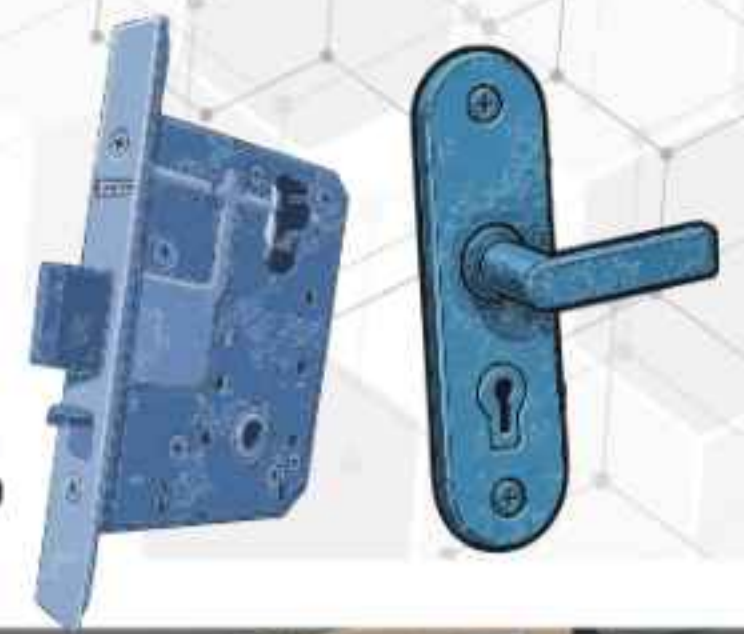

**LOCKTON commercial**

Art. **SQ-01C-25-SCP**

'Wide' (SQ. END) EXTERNAL Cylinder Hole & Lever

9 351307 011444 >

**LOCKTON commercial**

Art. **SQ-53C-25-BLK**

'Wide' (SQ. END) EXTERNAL Ind. Emerg. Turn & Lever



**BLACK**



9 351307 011710 >

**NEW**





## Packaging Update

*Easy Identification — At a Glance!*

**LOCKTON commercial**

Art. **SQ-01C-25-SCP**

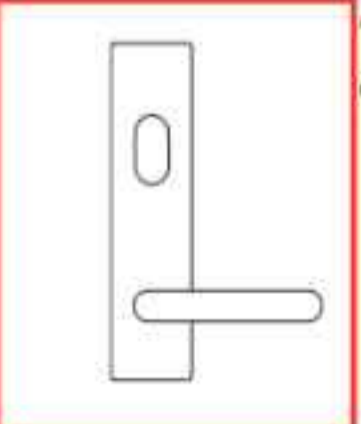
'Wide' (SQ. END) EXTERNAL Cylinder Hole & Lever

9 351307 011444 >

### Quick reference line drawing

- Instant visual identification
- See the product type at a glance

**LOCKTON commercial**

Art. **SQ-01C-25-SCP**

'Wide' (SQ. END) EXTERNAL Cylinder Hole & Lever





9 351307 011444 >

### Barcode for inventory control

- Simplifies stock management
- Ready for trade systems







# Commercial Range Additions

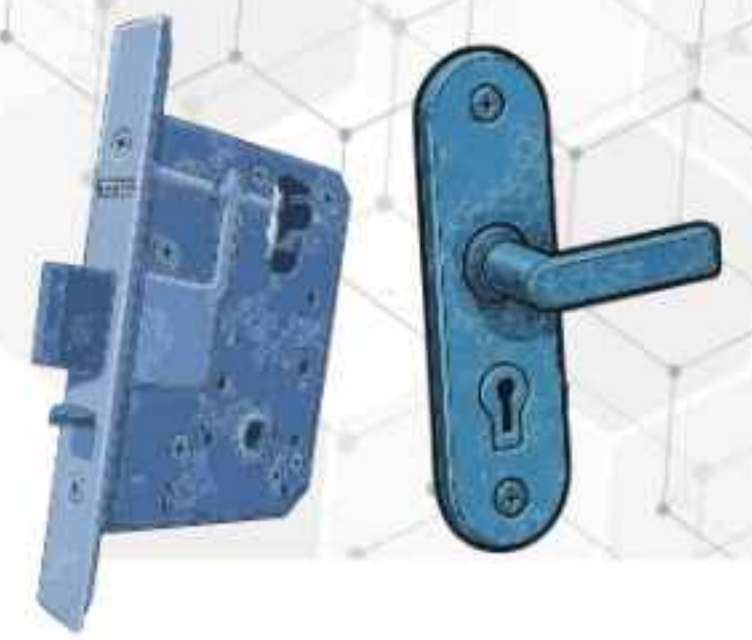

## 'Narrow' (SQ. END) EXTERNAL - Plain Plate \*BLACK\*

### PRODUCT DESCRIPTION

The LOCKTON Art. NSQ-05C-BLK - External Square Plain Plate w/ Matte Black Finish.

- Suits Narrow Stile Mortice Locks (Like: LOCKTON Art. SG-SBML23 or equivalent)
- Retrofits most existing Narrow Stile Furniture

### PRODUCT SPECIFICATION

- Material: Solid Brass (Plate)
- Finish: Matte Black (PVD)
- Mounting Screw Size: M4 x 55mm
- Supplied with: 4 x M4 Mounting Screws

### PLATE SPECIFICATION

- Dimensions (L x W x D): 185 x 25 x 14mm
- Mounting Screw Spacing: 160mm
- End Type: Square



Art ID. NSQ-05C-BLK



EXTERNAL - Plain Plate

## 'Wide' (SQ. END) EXTERNAL - Plain Plate \*BLACK\*

### PRODUCT DESCRIPTION

The LOCKTON Art. SQ-05C-BLK - External Plain Square Plate without Lever or Cylinder Hole w/ Matte Black Finish.

- Suits most 60mm Australian Mortice Locks
- Retrofits most existing Wide Plate Furniture

### PRODUCT SPECIFICATION

- Material: Solid Brass (Plate)
- Finish: Matte Black (PVD)
- Handing: N/A
- Mounting Screw Size: M5 x 55mm
- Supplied with: 4 x M4 Fixing Screws

### PLATE SPECIFICATION

- Dimensions (L x W x D): 165 x 46 x 12mm
- Mounting Screw Spacing: 150mm
- End Type: Square



Art ID. SQ-05C-BLK



EXTERNAL - Plain Plate

## Round (53mm Dia.) - Passage Furniture HALF SET

### PRODUCT DESCRIPTION

- Art. CYL-53-25-HF-SCP - Cylindrical Rose Passage Furniture Half Set - Lever & Blank Plate
- Suits most 60mm Australian Mortice Locks
- Can also be used for Cabinet Doors
- Vertical or horizontal through fix mounting options
- Rubber ring to hold trim cover
- Supplied as a set with solid spindle
- Existing 25 Series Levers can be swapped out with 30 & 32 Series Replacement Levers

### PRODUCT SPECIFICATION

- Material: Solid Brass Rose & Zinc Handle
- Handing: Easy change handing
- Quality Return Spring
- Vertical or horizontal through fix mounting options
- 41mm hole centres
- Suits doors 32mm - 50mm
- Rose - 53mm x 12mm
- Lever Length: 122mm
- Lever Diameter: 16mm
- Protrusion: 60mm

Art ID: CYL-53-25-HF-SCP



Art ID: CYL-53-25-HF-BLK

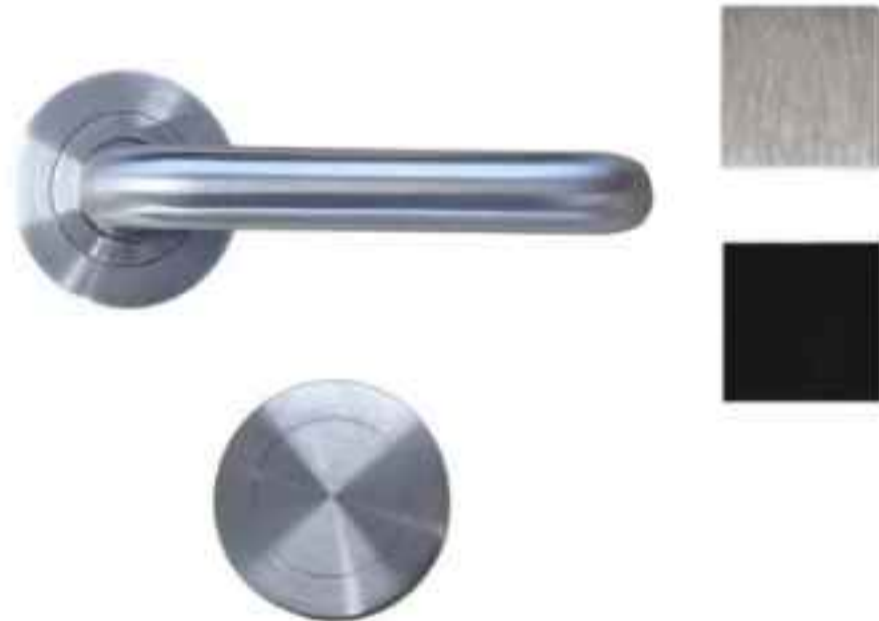

## Round (53mm Dia.) - Blank Rose (INTERNAL / EXTERNAL)FACE PLATE

### PRODUCT DESCRIPTION

- Art. CYL53-05CV - Blank Round Rose - 53mm Diameter
- Suits most 60mm Australian Mortice Locks
- Can be used on External or Internal edges for covering up marks and holes from previous rose furniture installations.

### PRODUCT SPECIFICATION

- Material: Solid Brass
- Finish: Satin Chrome or Black
- Rose Diameter: 53mm
- Rose Depth: 12mm
- Supplied with: 4 x Mounting Screws & 1 x Spindle

Art ID: CYL53-05CV



Art ID: CYL53-05CV-BLK







## STRIKE PAK

‘StrikePak’

*Stackable Strike Spacer System*

- *Correcting excessive door-to-frame gaps*



**SCAN  
TO WATCH**







# Mortice Lock Strike Packers



## STRIKE PAK

### PRODUCT DESCRIPTION

Designed specifically for Australian mortice locks, including narrow-stile and 60 mm body formats, the StrikePak range bridges oversized gaps between the door and frame using stackable modular packers for reliable latch engagement. The MP4 Main Packer Kit includes a 4 mm spacer, matching striker plate, and a full screw pack for both timber and metal frames, while the PE2 (2 mm), PE4 (4 mm), and PE8 (8 mm) Extra Packers allow precise on-site adjustment. All variations are available in Silver or Black finishes.



### 'StrikePak' MAIN STRIKE PLATE (4mm Thick)

Art ID: STPK-MP4-SIL



### PRODUCT SPECIFICATION

- Strike Plate Material: Stainless Steel
- Packer Material: Anodised Aluminium
- Dimensions (H x W x D): 90.8 mm x 32.4 mm x 4 mm
- Suits: 23, 30, 60 & 95 mm backset Australian mortice locks
- Includes Screw Pack:
  - 2 x Long Timber Screws (40 mm)
  - 2 x Short Timber Screws (30 mm)
  - 2 x Long Self-Tapping Metal Thread Screws (40 mm)
  - 2 x Short Self-Tapping Metal Thread Screws (30 mm)
  - 1 x Strike Plate
- Available in Silver or Black Finish
- 10-Year Warranty (\*)

Art ID: STPK-MP4-BLK

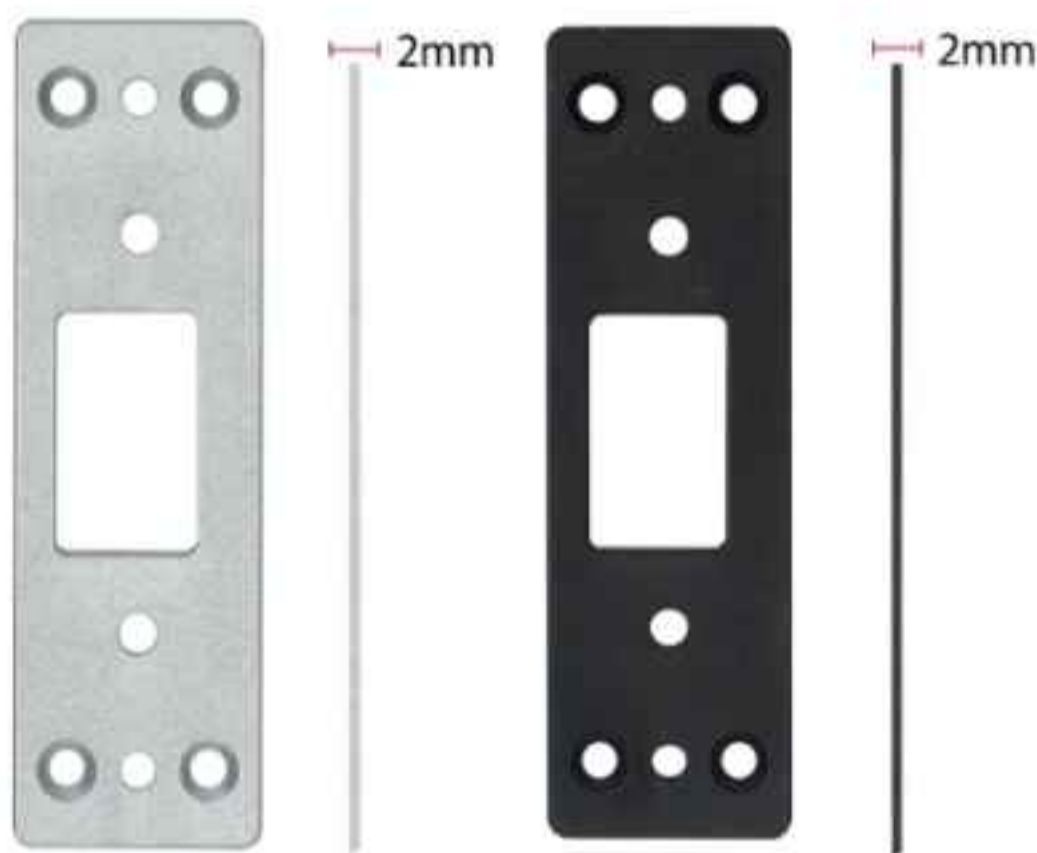

### 'StrikePak' PE2 EXTRA PACKER (2mm Thick)

Art ID: STPK-PE2-SIL



### PRODUCT SPECIFICATION

- Packer Material: Anodised Aluminium
- Dimensions (H x W x D): 90.8 mm x 32.4 mm x 2 mm
- Suits: 23, 30, 60 & 95 mm backset Australian mortice locks
- Available in Silver or Black Finish
- 10-Year Warranty (\*)

Art ID: STPK-PE2-BLK

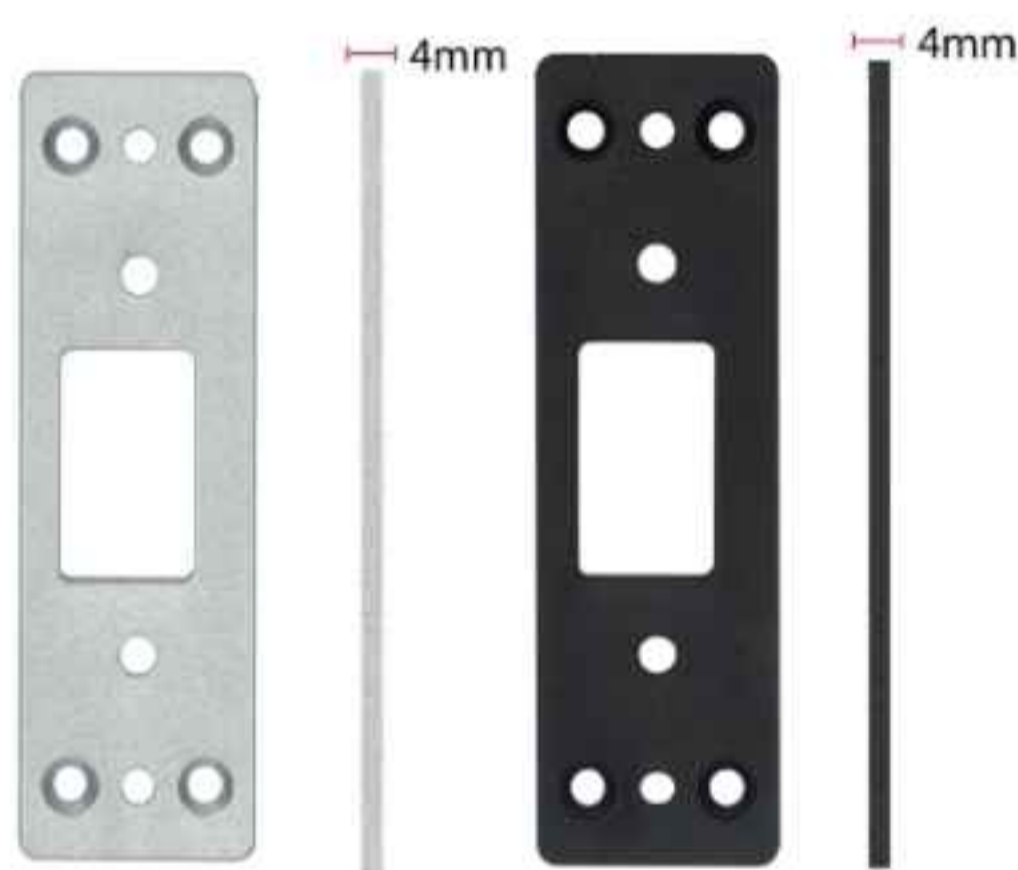

### 'StrikePak' PE4 EXTRA PACKER (4mm Thick)

Art ID: STPK-PE4-SIL



### PRODUCT SPECIFICATION

- Packer Material: Anodised Aluminium
- Dimensions (H x W x D): 90.8 mm x 32.4 mm x 4 mm
- Suits: 23, 30, 60 & 95 mm backset Australian mortice locks
- Available in Silver or Black Finish
- 10-Year Warranty (\*)

Art ID: STPK-PE4-BLK

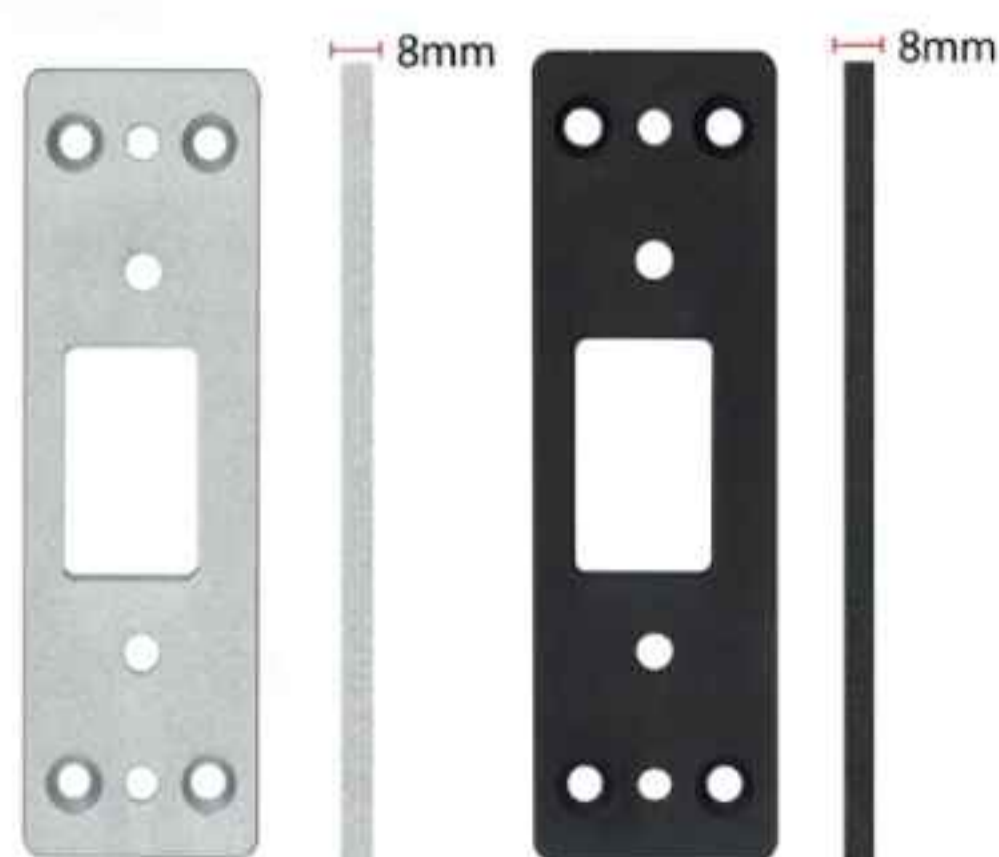

### 'StrikePak' PE8 EXTRA PACKER (8mm Thick)

Art ID: STPK-PE8-SIL



### PRODUCT SPECIFICATION

- Packer Material: Anodised Aluminium
- Dimensions (H x W x D): 90.8 mm x 32.4 mm x 8 mm
- Suits: 23, 30, 60 & 95 mm backset Australian mortice locks
- Available in Silver or Black Finish
- 10-Year Warranty (\*)

Art ID: STPK-PE8-BLK





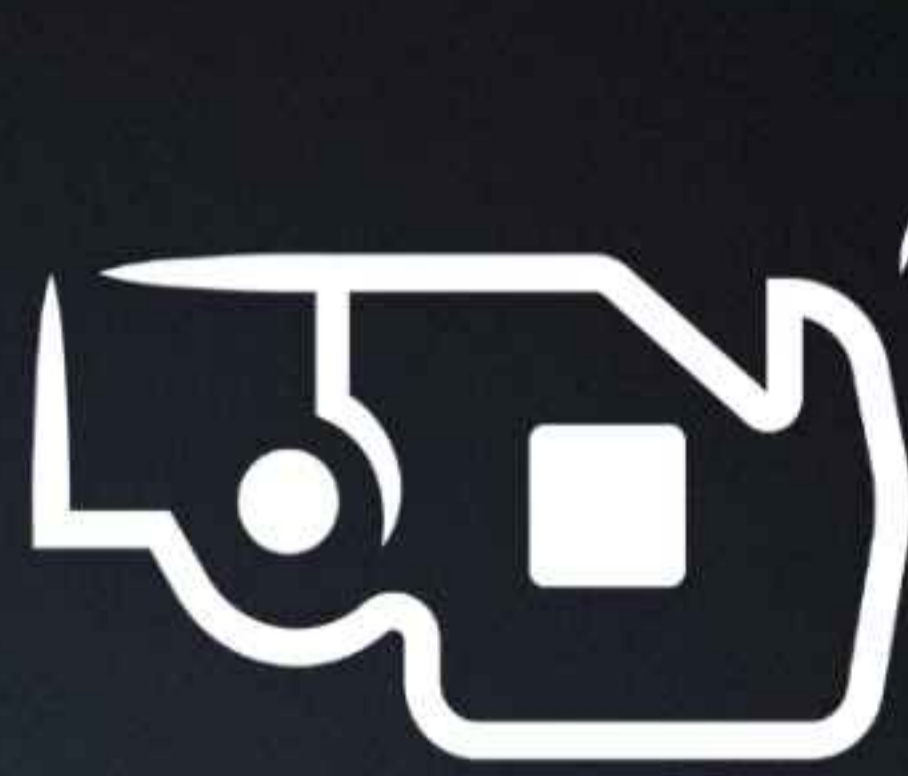

## QUICKDRAW

 Interchangeable Bolt Design

 200,000 Cycle Tested

**SS** Solid S/Steel Bolts & Body

 DDA Compliant Accessories



### 'QUICKDRAW' Swing Bolt Mortice Lock Series (QD)

Australian Registered Design  
No. 202610002

  
**SCAN  
TO WATCH**







## WHY CHOOSE QUICKDRAW

- 3 Stainless Steel Bolt Versions  
(22mm, 36mm & 28mm Hook)
- Tested to **200,000** Cycles for Durability
- Retrofits Existing 590 Mortice Locks
- Hockey Stick Cylinder Retaining Pin
- 3mm Stainless Steel Faceplate
- Quick change Bolt Design
- DDA Compliant Accessories available
- Satin Stainless Steel or Matte Black Finishes

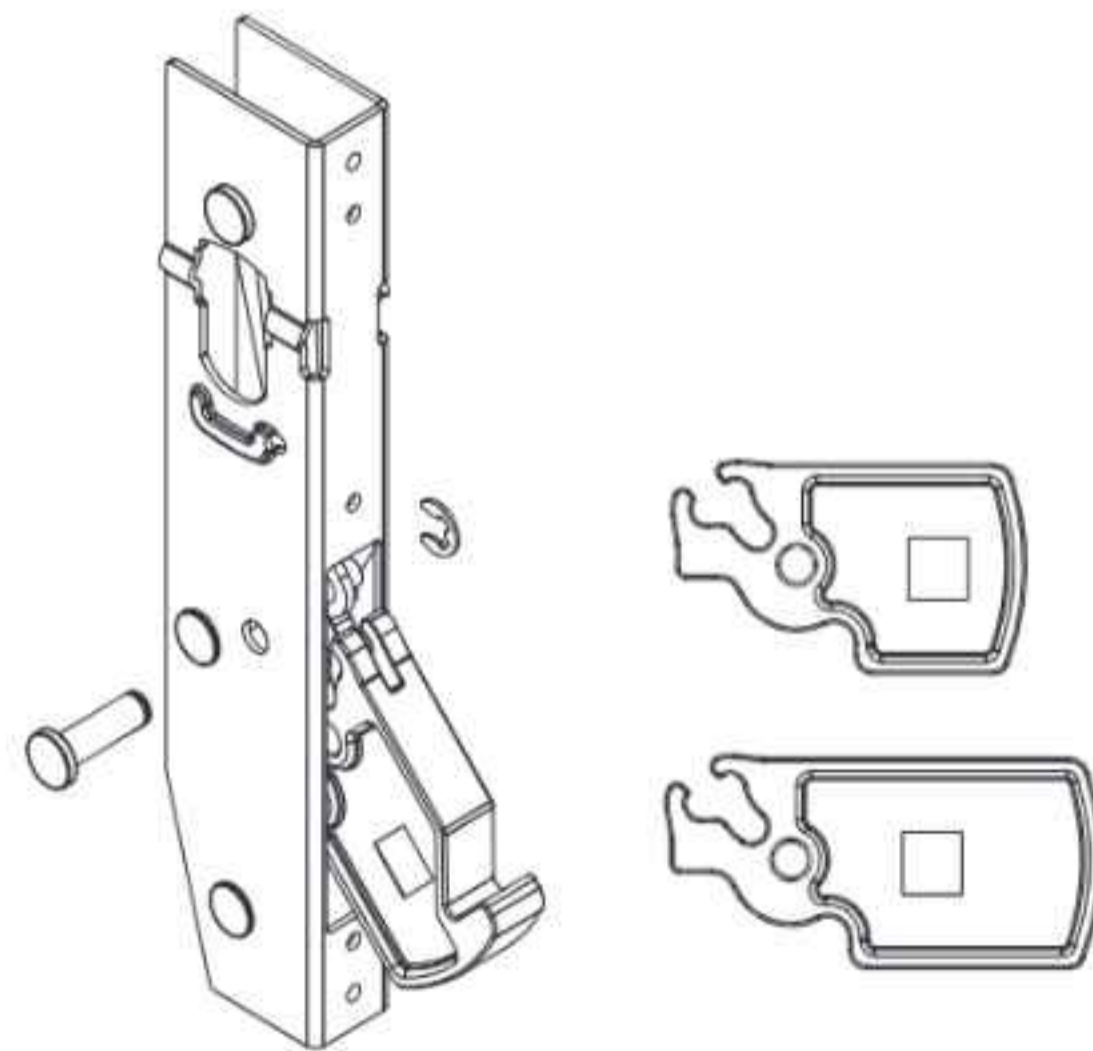

**10 YEARS** WARRANTY 

**SCAN TO WATCH**







# Swing Bolt Range



## 'QUICKDRAW' - Swing Bolt Mortice Lock Series (QD)

### PRODUCT DESCRIPTION

*"Strength, Speed, Compatibility – in One Lock Series"*

*The QUICKDRAW range has been purpose-designed to retrofit existing 590 mortice locks while delivering significant performance enhancements and installer-focused benefits such as a quick change bolt system for on-the-fly function changes.*

*"Hockey Stick" style cylinder retaining pins make re-keying or cylinder replacement jobs more efficient and convenient.*

*The Stainless Steel construction on both lock body & faceplate plus extensive cycle testing ensures longevity and durability for demanding environments.*

## QuickDraw - Mortice Lock Bodies



### 'QuickDraw' SWING BOLT \*22mm\* (Short Throw) Mortice Lock

#### PRODUCT SPECIFICATION

- Bolt Length: 22mm (Can be converted to 36mm Bolt or 28mm Hook Bolt)
- Material: Stainless Steel
- Finish: Satin Stainless Steel or Matte Black
- Dimensions (H x W x D): 181 x 36 x 18.4mm
- Faceplate Dimensions (L x W x T): 155 x 25 x 3mm
- 10 Year Warranty (\*)
- Cycle Tested : 200,000 Cycles

Art ID: 590ML-QD-22B

QTY  
\$



Art ID: 590ML-QD-22B-BLK

QTY  
\$



### 'QuickDraw' SWING BOLT \*36mm\* (Long Throw) Mortice Lock

#### PRODUCT SPECIFICATION

- Bolt Length: 36mm Bolt (Can be converted to 22mm Bolt or 28mm Hook Bolt)
- Material: Stainless Steel
- Finish: Satin Stainless Steel or Matte Black
- Dimensions (H x W x D): 181 x 36 x 18.4mm
- Faceplate Dimensions (L x W x T): 155 x 25 x 3mm
- 10 Year Warranty (\*)
- Cycle Tested : 200,000 Cycles

Art ID: 590ML-QD-36B

QTY  
\$



Art ID: 590ML-QD-36B-BLK

QTY  
\$



### 'QuickDraw' SWING BOLT \*28mm\* (Hook Bolt) Mortice Lock

#### PRODUCT SPECIFICATION

- Bolt Length: 28mm Hook Bolt (Can be converted to 22mm or 36mm Bolt)
- Material: Stainless Steel
- Finish: Satin Stainless Steel or Matte Black
- Dimensions (H x W x D): 181 x 36 x 18.4mm
- Faceplate Dimensions (L x W x T): 155 x 25 x 3mm
- 10 Year Warranty (\*)
- Cycle Tested : 200,000 Cycles

Art ID: 590ML-QD-28HKB

QTY  
\$



Art ID: 590ML-QD-28HKB-BLK

QTY  
\$







## 'QUICKDRAW' - Bolt Swap Kits



### PRODUCT DESCRIPTION

The LOCKTON 'QuickDraw' Bolt Swap Kit range gives installers instant flexibility, letting you switch between bolt types in seconds. Carry a few kits and you're ready for any installation that calls for a swing bolt or hook bolt solution.



## QuickDraw - Bolt Swap Kits

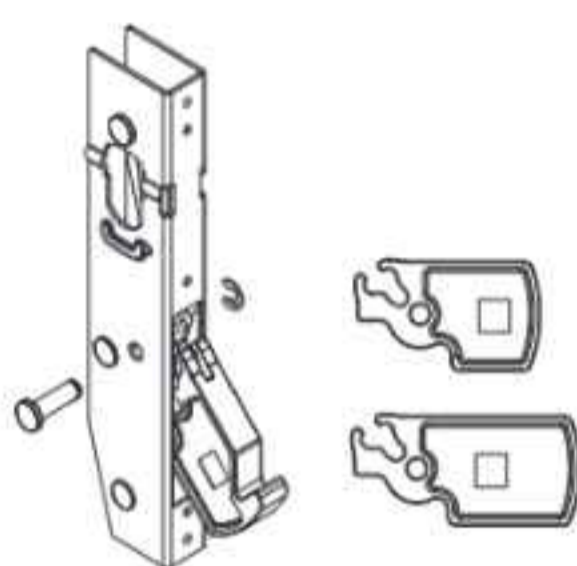

### 'QuickDraw' BOLT SWAP KIT - Inc. 22mm (Short) BOLT + S/Steel FACE PLATE

#### Kit Contains

- 1 x 22mm 'QuickDraw' Bolt
- 1 x Stainless Steel Face Plate for 22mm Swing Bolt Mortice Lock

Art ID. BLT-QD-22B-KIT

#### PRODUCT SPECIFICATION

- Bolt Dimensions (L x W): 60 x 35mm
- Faceplate Dimensions (L x W x T): 155 x 25 x 3mm
- Bolt & Plate Material: Stainless Steel



### 'QuickDraw' BOLT SWAP KIT - Inc. 36mm (Long) BOLT + S/Steel FACE PLATE

#### Kit Contains

- 1 x 36mm 'QuickDraw' Bolt
- 1 x Stainless Steel Face Plate for 36mm Swing Bolt Mortice Lock

Art ID. BLT-QD-36B-KIT

#### PRODUCT SPECIFICATION

- Bolt Dimensions (L x W): 75 x 35mm
- Faceplate Dimensions (L x W x T): 155 x 25 x 3mm
- Bolt & Plate Material: Stainless Steel



### 'QuickDraw' BOLT SWAP KIT - Inc. 28mm (Hook) BOLT + Latching STRIKE + S/Steel

#### Kit Contains

- 1 x 28mm 'QuickDraw' Hook Bolt
- 1 x Latching Strike
- 1 x Stainless Steel Face Plate for 28mm Hook Swing Bolt Mortice Lock

Art ID. BLT-QD-28HKB-KIT

#### PRODUCT SPECIFICATION

- Bolt Dimensions (L x W): 65 x 35mm
- Faceplate Dimensions (L x W x T): 155 x 25 x 3mm
- Strike Plate Dimensions (L x W x T): 125 x 25 x 3mm
- Latching Strike Dimensions (L x W x D): 146 x 20 x 25mm
- Bolt, Strike & Plate Material: Stainless Steel





# Swing Bolt Range



## 'QUICKDRAW' Timber Door kits



**QUICKDRAW**

### RANGE DESCRIPTION

The QUICKDRAW Timber Kits extend the versatility of the QUICKDRAW 590 mortice lock series by enabling seamless installation on timber doors.

Each kit includes a purpose-built Timber Faceplate and matching Timber Strike that fit directly to the QUICKDRAW primary mortice lock body, ensuring correct alignment, secure mounting, and reliable operation on timber frames.

Ideal for commercial, specialty, or mixed-material projects, the Timber Kit delivers a clean, secure, and professional finish on timber door installations.



## QuickDraw' Extended (for TIMBER) FACEPLATE & STRIKE PLATE - KIT - Suits (590ML-QD-22) 22 mm\* (Short Throw)

### PRODUCT DESCRIPTION

The LOCKTON Art. TBR-QD-22B-KIT 'QuickDraw' Timber Kit includes an extended Timber Faceplate and matching extended Timber Strike Plate, designed to suit the QUICKDRAW 22 mm\* (Short Throw) Mortice Lock Body for installation on timber doors. The extended design also helps cover larger cut-outs for a clean, professional finish.

Art ID. TBR-QD-22B-KIT

### PRODUCT SPECIFICATION

#### FACEPLATE - SPECS

- Dimensions (L x W): 222 x 25mm
- Plate Thickness: 3mm
- Supplied with: 5 x Fixing Screws
- Material: Stainless Steel

#### STRIKEPLATE - SPECS

- Dimensions (L x W): 183 x 25mm
- Plate Thickness: 2mm
- Supplied with: 2 x Fixing Screws
- Material: Stainless Steel



## QuickDraw' Extended (for TIMBER) FACEPLATE & STRIKE PLATE - KIT - Suits (590ML-QD-36) 36 mm\* (Long Throw)

### PRODUCT DESCRIPTION

The LOCKTON Art. TBR-QD-36B-KIT 'QuickDraw' Timber Kit includes an extended Timber Faceplate and matching extended Timber Strike Plate, designed to suit the QUICKDRAW 36 mm\* (Long Throw) Mortice Lock Body for installation on timber doors. The extended design also helps cover larger cut-outs for a clean, professional finish.

Art ID. TBR-QD-36B-KIT

Ex GST

### PRODUCT SPECIFICATION

#### FACEPLATE - SPECS

- Dimensions (L x W): 222 x 25mm
- Plate Thickness: 3mm
- Supplied with: 5 x Fixing Screws
- Material: Stainless Steel

#### STRIKEPLATE - SPECS

- Dimensions (L x W): 183 x 25mm
- Plate Thickness: 2mm
- Supplied with: 2 x Fixing Screws
- Material: Stainless Steel



## QuickDraw' Extended (for TIMBER) FACEPLATE & STRIKE PLATE - KIT - Suits (590ML-QD-28) 28 mm\* (Hook Bolt)

### PRODUCT DESCRIPTION

The LOCKTON Art. TBR-QD-28HKB-KIT 'QuickDraw' Timber Kit includes an extended Timber Faceplate and matching extended Timber Strike Plate, designed to suit the QUICKDRAW 28 mm\* (Hook Bolt) Mortice Lock Body for installation on timber doors. The extended design also helps cover larger cut-outs for a clean, professional finish.

Art ID. TBR-QD-28HKB-KIT

### PRODUCT SPECIFICATION

#### FACEPLATE - SPECS

- Dimensions (L x W): 222 x 25mm
- Plate Thickness: 3mm
- Supplied with: 5 x Fixing Screws
- Material: Stainless Steel

#### STRIKEPLATE - SPECS

- Dimensions (L x W): 183 x 28.5mm
- Plate Thickness: 2mm
- Supplied with: 4 x Fixing Screws
- Material: Stainless Steel





## QuickDraw - DDA Exit Snibs



Design for Access and mobility - AS1428.1-2009



'QuickDraw' EXIT SNIB  
- suits Swing Bolt (590) Mortice Lock (Oval Cyl Fit)

### PRODUCT SPECIFICATION

- Material: Solid Brass
- Reversible Handing
- Snib Length: 55mm
- Satin Chrome Finish
- Comes with "Rabbit Ear" Cams
- Meets the requirements of AS1428.1-2009, design for access and mobility
- 10 Year Warranty (\*)

Art ID. 590CYL-13VDA-SC



'QuickDraw' EXIT SNIB  
- suits Swing Bolt (590) Mortice Lock (Oval Cyl Fit) \*Matte Black\*

### PRODUCT SPECIFICATION

- Material: Solid Brass
- Reversible Handing
- Snib Length: 55mm
- Matte Black (PVD) Finish
- Comes with "Rabbit Ear" Cams
- Meets the requirements of AS1428.1-2009, design for access and mobility
- 10 Year Warranty (\*)

Art ID. 590CYL-13VDA-BLK



'QuickDraw' ESCAPE LEVER  
- suits Swing Bolt (590) Mortice Lock (Oval Cyl Fit)

### PRODUCT SPECIFICATION

- Material: Solid Brass
- Reversible Handing
- Lever Length: 100mm
- Satin Chrome Finish
- Comes with "Rabbit Ear" Cams
- Meets the requirements of AS1428.1-2009, design for access and mobility
- 10 Year Warranty (\*)

Art ID. 590CYL-EL-SC



'QuickDraw' ESCAPE LEVER  
- suits Swing Bolt (590) Mortice Lock (Oval Cyl Fit) \*Matte Black\*

### PRODUCT SPECIFICATION

- Material: Solid Brass
- Reversible Handing
- Lever Length: 100mm
- Matte Black (PVD) Finish
- Comes with "Rabbit Ear" Cams
- Meets the requirements of AS1428.1-2009, design for access and mobility
- 10 Year Warranty (\*)

Art ID. 590CYL-EL-BLK







# Mortice Lock Furniture

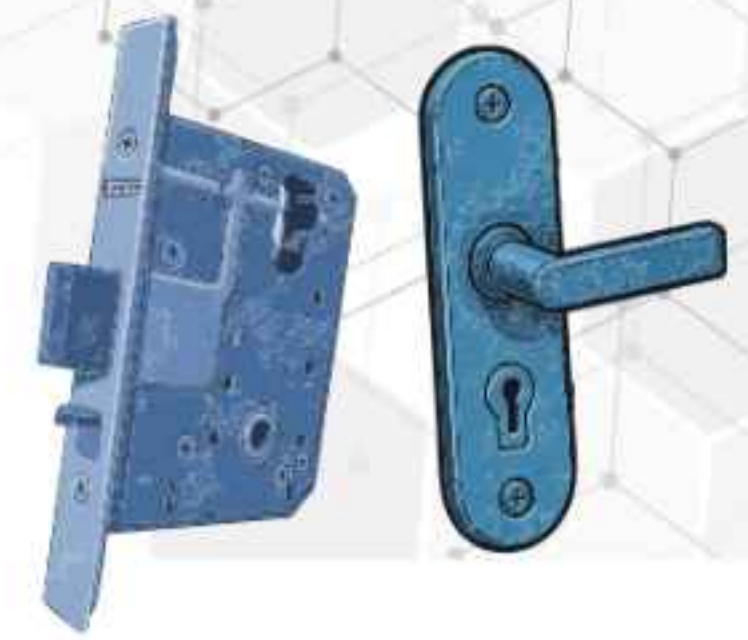

## External Furniture Range



### LEG-TON' (SQ. END) - EXTERNAL Furniture Range

#### PRODUCT DESCRIPTION

*"Many Brands - One Interchangeable Solution"*  
The 'LEG-TON' Furniture range is designed to be an interchangeable furniture solution for all major Australian and New Zealand Mortice Lock Furniture Brands such as LOCKWOOD™, DORMAKABA™ & LEGGE™. The External Furniture comes with a multi-thread design that aligns with every common mounting screw pattern. The flexible application of the range means you can easily replace one or both sides of existing furniture installations. It is also carefully designed to cover existing marks, holes and paint outlines from previous installations.

#### PRODUCT SPECIFICATION

- Material: Solid Brass (Plate & Handle)
- Handing: Easy change handing
- Quality Return Spring
- Mounting Screw Size: M4 x 68mm
- Supplied with: 2 x M4 Fixing Screws
- 10 Year Warranty (\*)

#### PLATE SPECIFICATIONS

- Dimensions (L x W x D): 175 x 48 x 12mm
- Mounting Screw Spacing: 148 or 158mm
- End Type: Square

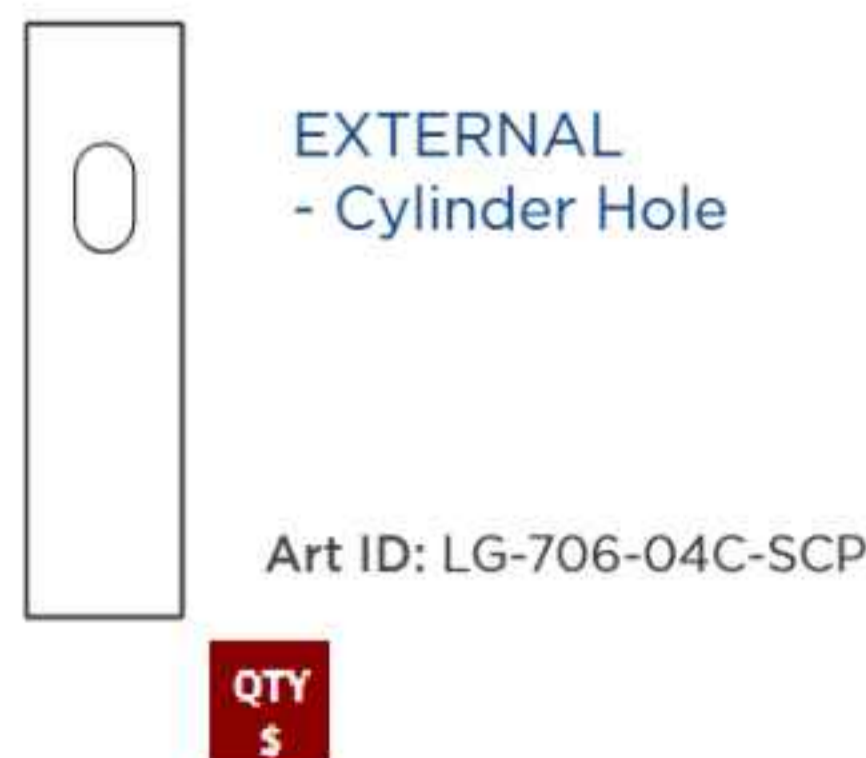
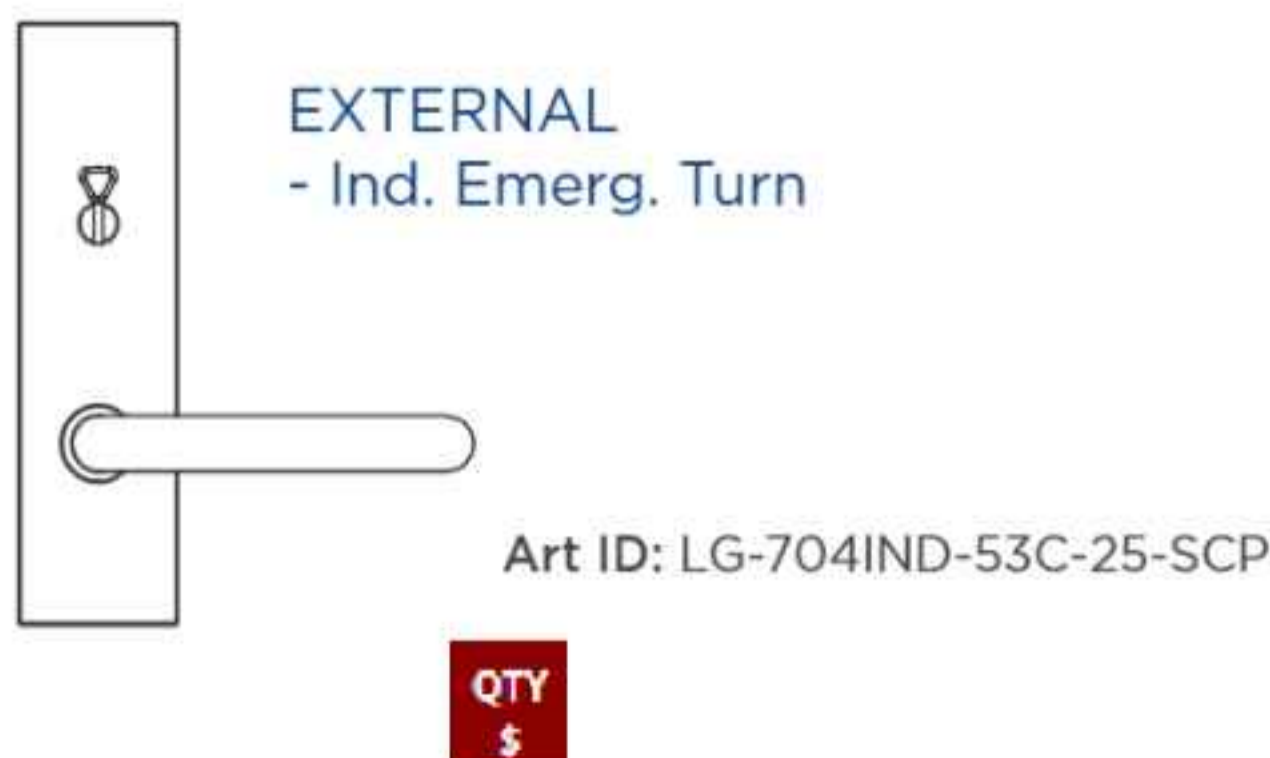
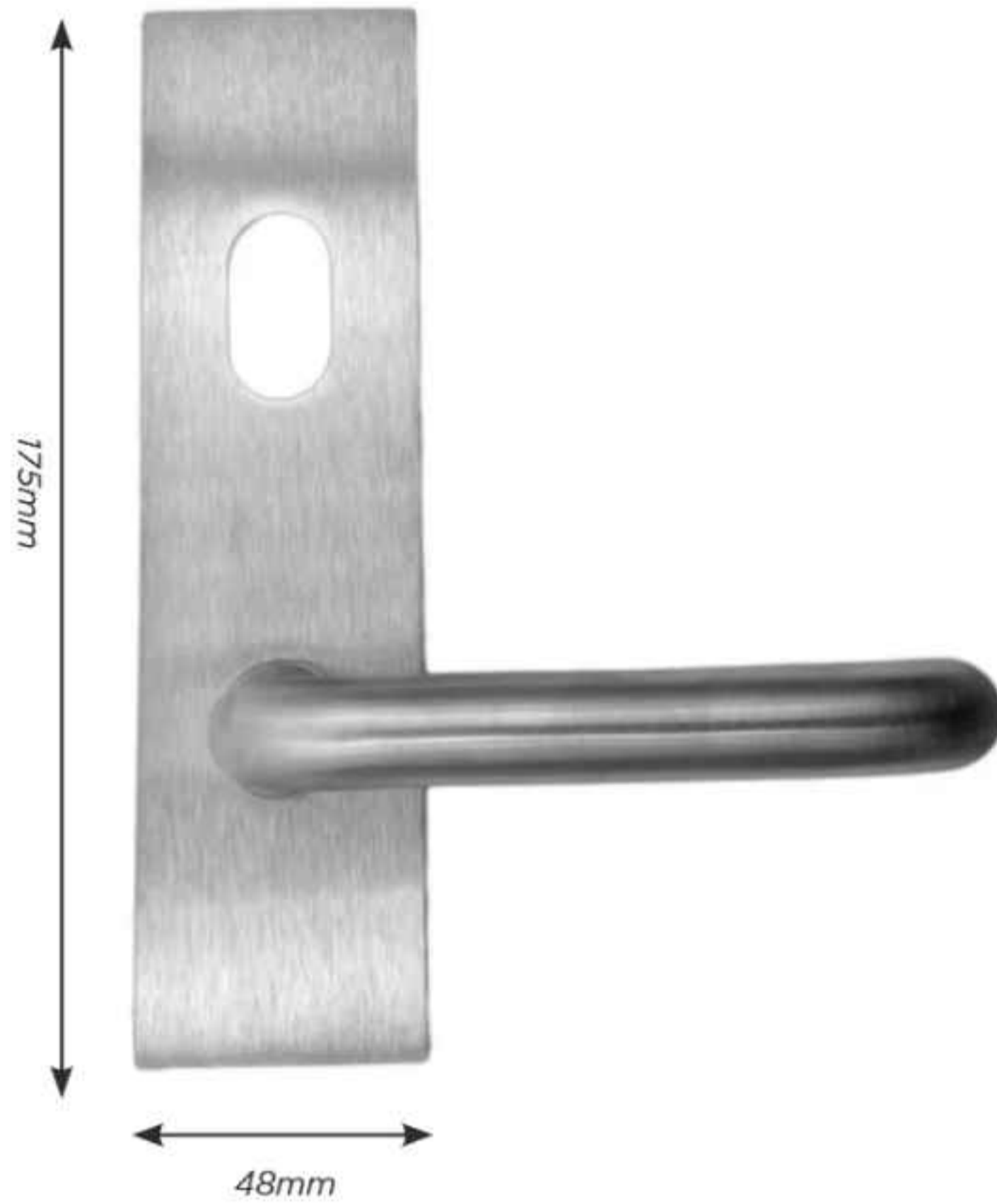
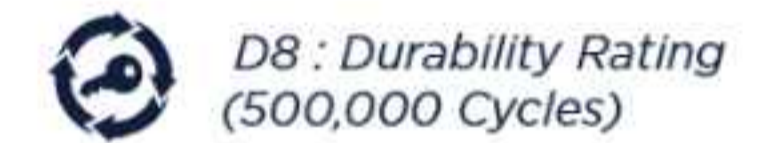
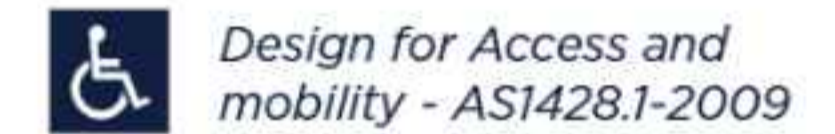





# Mortice Lock Furniture

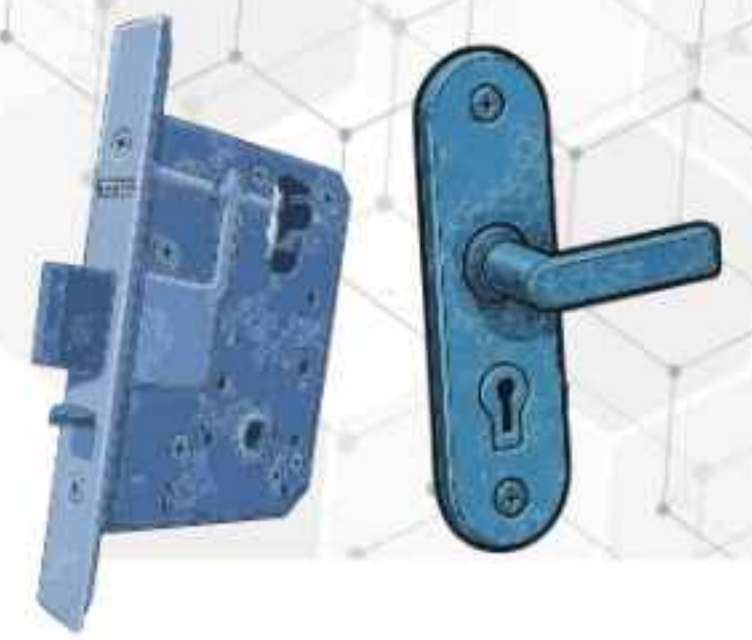

## Internal Furniture Range

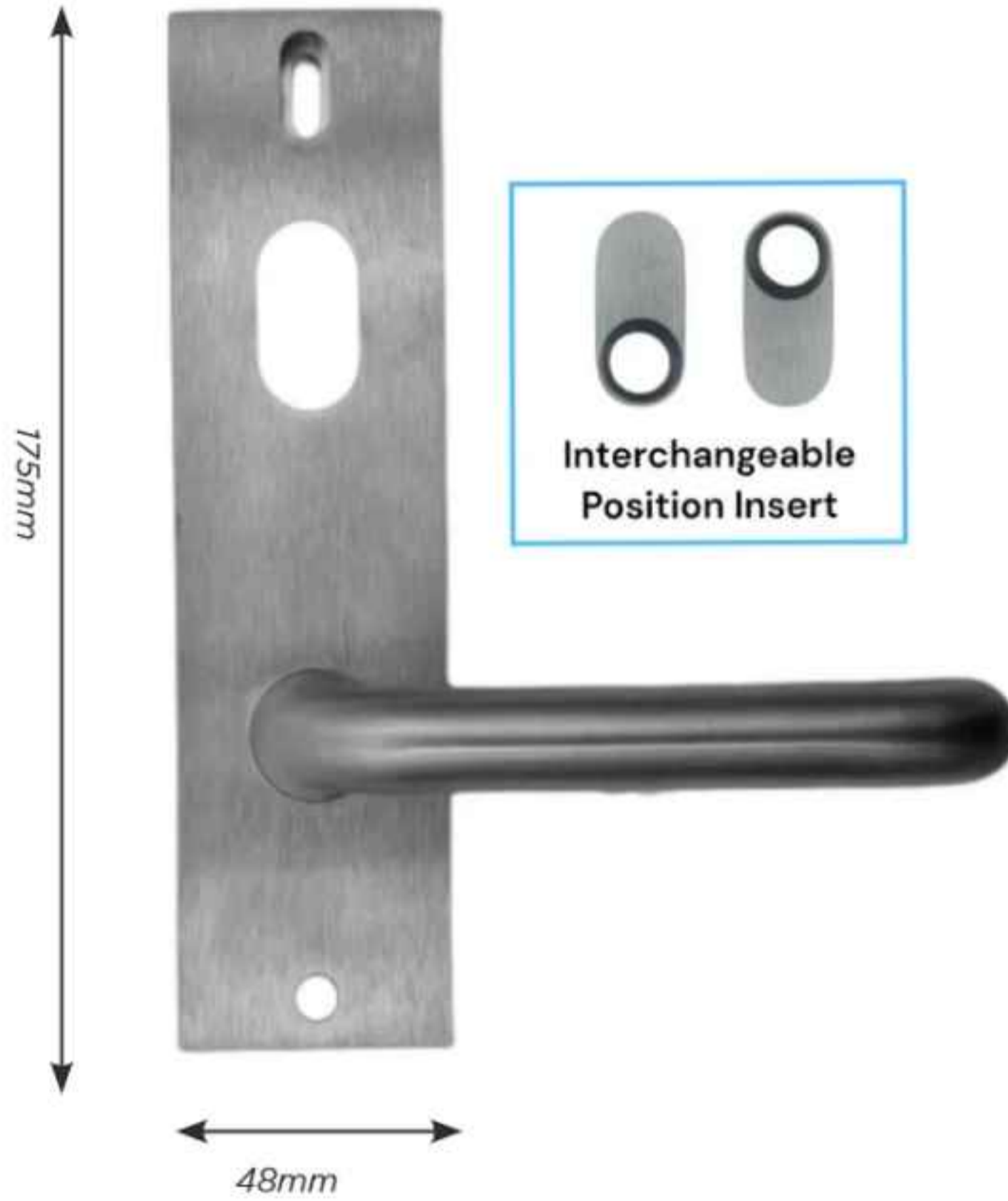

### LEG-TON' (SQ. END) - INTERNAL Furniture Range

#### PRODUCT DESCRIPTION

*"Many Brands - One Interchangeable Solution"*

The 'LEG-TON' Furniture range is designed to be an interchangeable furniture solution for all major Australian and New Zealand Mortice Lock Furniture Brands such as LOCKWOOD™, DORMAKABA™ & LEGGE™. The Internal Furniture comes with an easy to fit rotatable insert - Select Top Hole for LEGGE™ or Bottom Hole for all other brands. The flexible application of the range means you can easily replace one or both sides of existing furniture installations. It is also carefully designed to cover existing marks, holes and paint outlines from previous installations.

#### PRODUCT SPECIFICATION

- Material: Solid Brass (Plate & Handle)
- Handing: Easy change handing
- Quality Return Spring
- Mounting Screw Size: M4 x 68mm
- Supplied with: 2 x M4 Fixing Screws & 1 x Screw Position Insert
- 10 Year Warranty (\*)

#### PLATE SPECIFICATIONS

- Dimensions (L x W x D): 175 x 48 x 12mm
- Mounting Screw Spacing: 148 or 158mm
- End Type: Square



Design for Access and mobility - AS1428.1-2009



D8 : Durability Rating (500,000 Cycles)







KEY TAG BARREL -  
Asst. FLURO COLOURS  
- 140 KEY TAGS

Art ID.  
KTFR5-FD140

KEY TAG JAR -  
Asst. FLURO COLOURS  
- 175 KEY TAGS

Art ID.  
KTFR5-FD175

# LOCKTON - FLURO RANGE KEY TAGS







# Key Tags



KEY TAGS  
(FLURO RANGE)  
**\*Safety Yellow\***  
- Pkt of 20

Art ID.  
KTFR5-FYE



KEY TAGS  
(FLURO RANGE)  
**\*Green Gecko\***  
- Pkt of 20

Art ID.  
KTFR5-FGN



KEY TAGS  
(FLURO RANGE)  
**\*Pink Glo\***  
- Pkt of 20

Art ID.  
KTFR5-FPK



KEY TAGS  
(FLURO RANGE)  
**\*Orange Clown-Fish\***  
- Pkt of 20

Art ID.  
KTFR5-FOR



KEY TAGS  
(FLURO RANGE)  
**\*Glow-In-Dark White\***  
- Pkt of 20

Art ID.  
KTFR5-GWH



KEY TAG REFILL -  
Asst. FLURO Colours  
- 175 KEY TAGS  
(Qty 35 of 5 Fluro  
Colours)

Art ID.  
KTFR5-FRF175



KEY TAG REFILL -  
Asst. FLURO Colours  
- 70 KEY TAGS  
(Qty 14 of 5 Fluro  
Colours)

Art ID.  
KTFR5-FRF70





## CADELL **52**

Commercial **A**nd Domestic **E**lectronic **L**ever **L**ock

**NEW** **STAINLESS STEEL COVER**



### PRODUCT SPECIFICATION

- Material: Stainless Steel
- Dimensions (H x W x D): 120 x 75 x 62mm
- Finish: Satin Stainless Steel or Matte Black
- Supplied with 5 x Fixing Screws



'E-Series' Weather Cover - Suits CADELL52 Electronic Locks \*Satin Stainless

'E-Series' Weather Cover - Suits CADELL52 Electronic Locks \*Black\*

Art ID. CADELL52-WC-SSS

Art ID. CADELL52-WC-BLK





## Architectural Floor Mounted DOORSTOPS



BOX of 30  
BOX QTY. DISCOUNT  
AVAILABLE

'Architectural' DOORSTOP - 45 dia. x 24mm (h)  
\*Floor Mounted\* 304 Stainless Steel



### PRODUCT DESCRIPTION

LOCKTON Art. DS4524-F-SSS Floor Mounted 'Architectural' Doorstop.  
This high quality doorstop is designed for floor mounting to help prevent doors from swinging directly into walls or frames and indirectly causing damage via the mounted door furniture.

Art ID: DS4524-F-SSS



### PRODUCT SPECIFICATION

- Material: 304 Stainless Steel
- Finish: Satin Stainless Steel or Black
- Diameter: 45mm
- Height: 24mm
- Incl. fixing material
- 10 Year Warranty (\*)

Art ID: DS4524-F-BLK



BOX of 20  
BOX QTY. DISCOUNT  
AVAILABLE

'Architectural' DOORSTOP - 35 dia. x 40mm (h)  
\*Floor Mounted\* 304 Stainless Steel



### PRODUCT DESCRIPTION

LOCKTON Art. DS3540-F-SSS Floor Mounted 'Architectural' Doorstop.  
This high quality doorstop is designed for floor mounting to help prevent doors from swinging directly into walls or frames and indirectly causing damage via the mounted door furniture.

Art ID: DS3540-F-SSS



### PRODUCT SPECIFICATION

- Material: 304 Stainless Steel
- Finish: Satin Stainless Steel or Black
- Diameter: 35mm
- Height: 40mm
- Incl. fixing material
- 10 Year Warranty (\*)

Art ID: DS3540-F-BLK





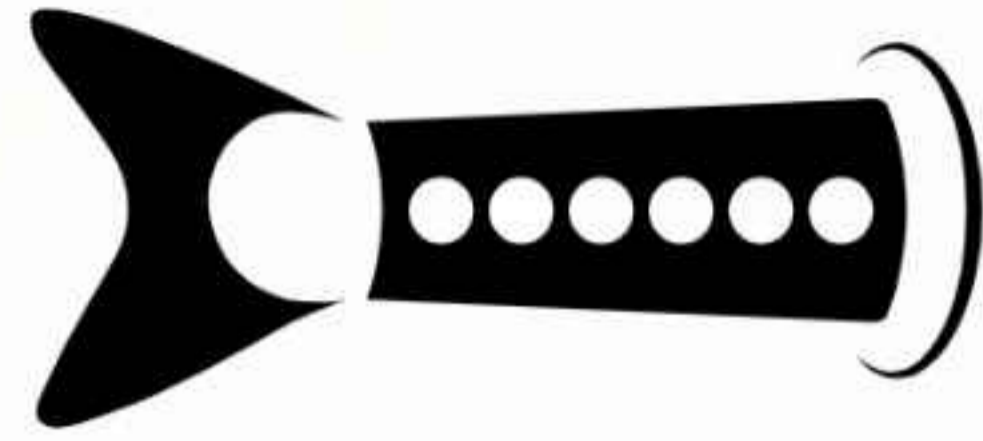
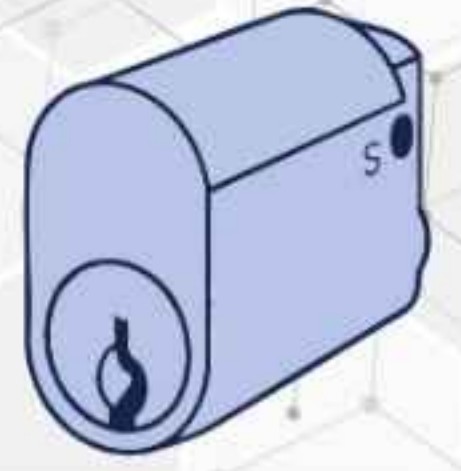

# FISHTAIL



## Universal BARREL EXTENSION SYSTEM *- For Oval Cylinders*

Patent Rights Reserved in  
Australia & Internationally  
AU2025904757



**SCAN  
TO WATCH**



**LOCKTON**  
GUARD WHAT MATTERS



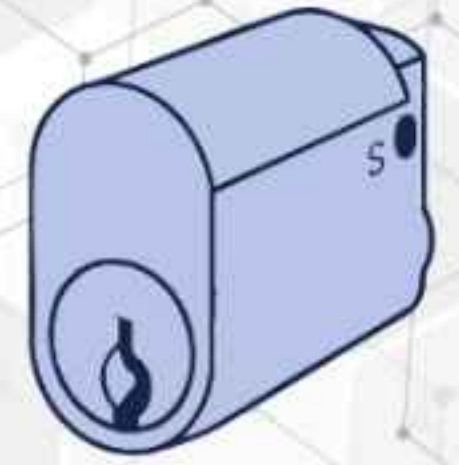

## Extended Oval Cylinder Range - 50mm

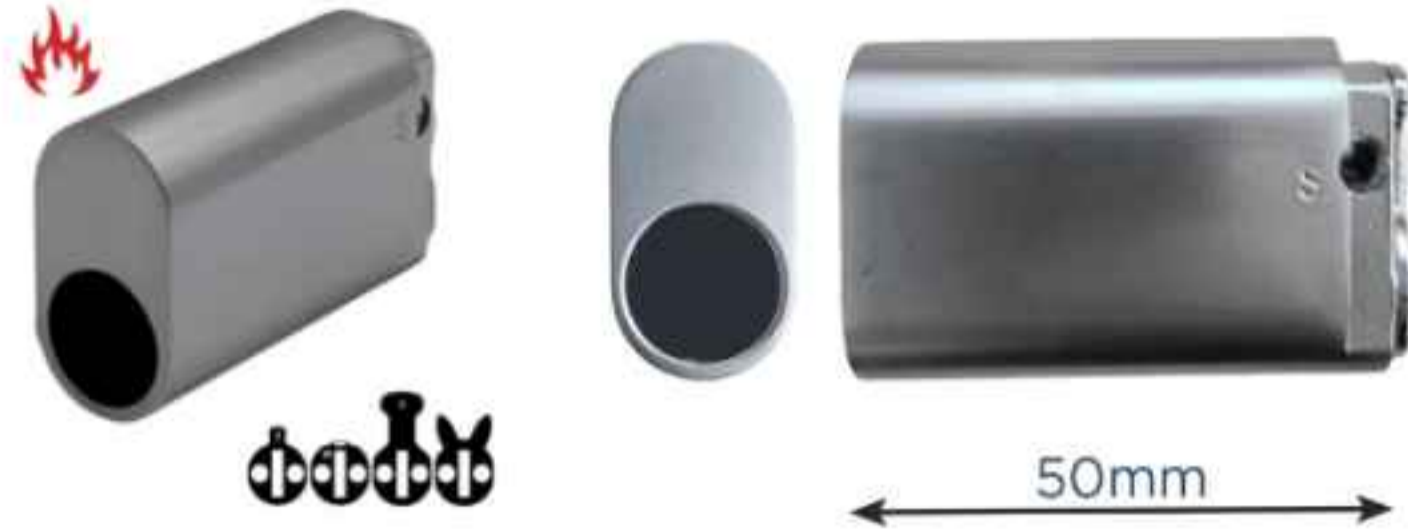

Door Thickness:  
Wide Plate Furniture  
65mm - 85mm  
CADELL52 Furniture  
32mm - 64mm

Art ID.

Description

410/50-SC-ALB

570 OVAL CYL. \*EXTENDED\* 50mm (ALB) \*Satin Chrome\*

QTY \$



## FISHTAIL

FishTail BARREL EXTENSION (570) - suits 50mm Oval Cylinder Housing



Art ID. 410-FT-EXT50

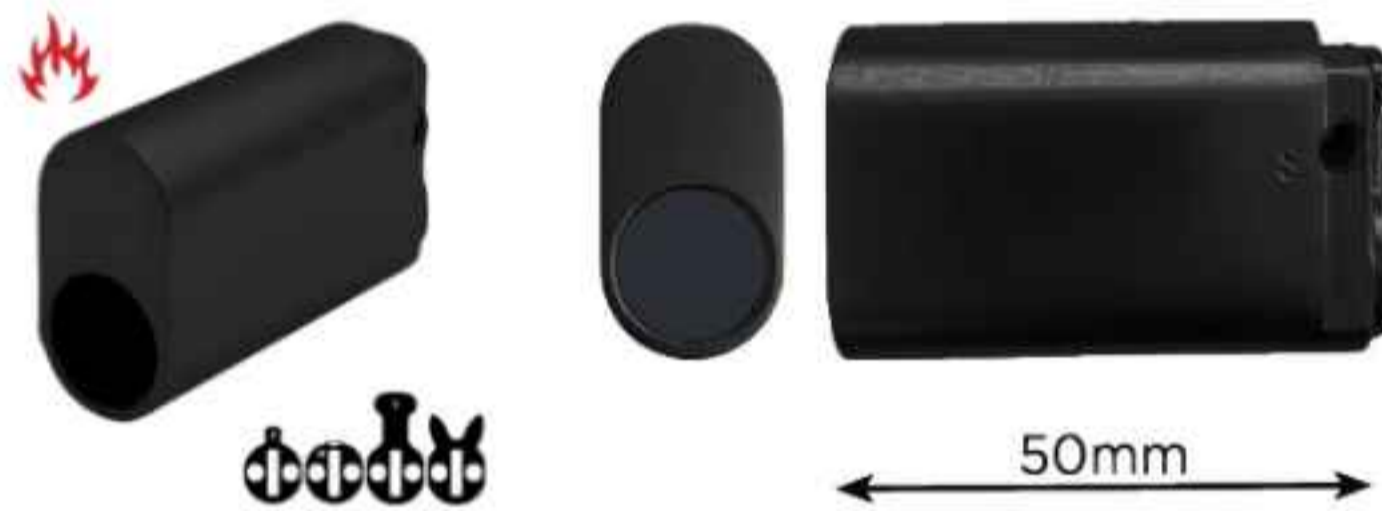

Door Thickness:  
Wide Plate Furniture  
65mm - 85mm  
CADELL52 Furniture  
32mm - 64mm

Art ID.

Description

410/50-BLK-ALB

570 OVAL CYL. \*EXTENDED\* 50mm (ALB) \*Matte Black\*

QTY \$

## Extended Oval Cylinder Range - 62mm

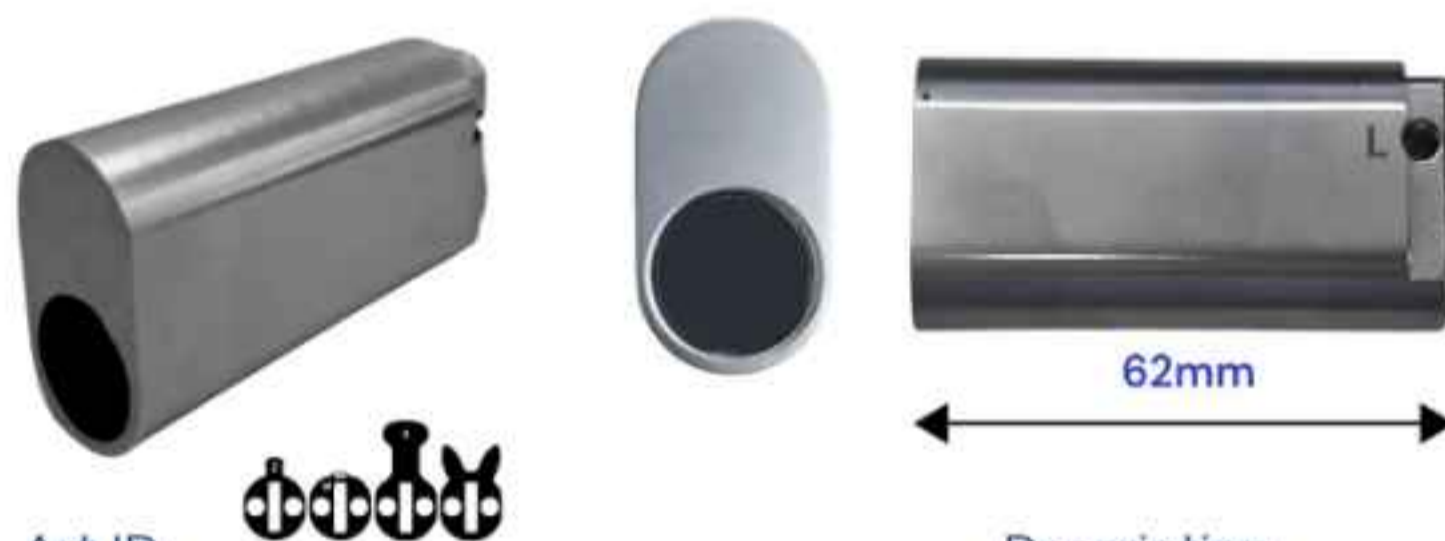

Door Thickness:  
Wide Plate Furniture  
85mm - 110mm  
CADELL52 Furniture  
64mm - 90mm

Art ID.

Description

410/62-SC-ALB

570 OVAL CYL. \*EXTENDED\* 62mm (ALB) \*Satin Chrome\*

QTY \$



## FISHTAIL

FishTail BARREL EXTENSION (570) - suits 62mm Oval Cylinder Housing



Art ID. 410-FT-EXT62



Door Thickness:  
Wide Plate Furniture  
85mm - 110mm  
CADELL52 Furniture  
64mm - 90mm

Art ID.

Description

410/62-BLK-ALB

570 OVAL CYL. \*EXTENDED\* 62mm (ALB) \*Matte Black\*

QTY \$



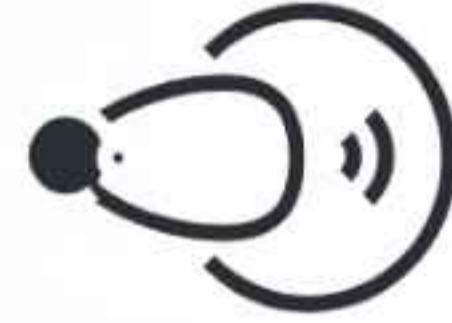

# REBADGE



## Advanced KEY FOB DUPLICATOR

### PRODUCT DESCRIPTION

JMA Art. REBADGE-2-KIT Advanced Key Fob Duplicator w/ 25 Pack of Cloneable Fobs  
 The REBADGE-2 enables quick, easy and secure duplication/cloning of Proximity Key Fobs for a wide range of Access Control systems across the market.  
 The copying process is made easy and intuitive via the companion JMARebadgePro app with step by step instructions (available on Android and iOS).  
 The app also keeps a record of all fob copies made making repeat jobs even faster and easier.  
 The device is highly portable and easy to carry with a built-in rechargeable battery enabling quick and efficient mobile servicing.  
 Can copy access fobs/cards based on 13.56 Mhz and 125 kHz systems and is also compatible with some Anti-Copy Closed Systems.

### PRODUCT SPECIFICATION

- Battery: 3.7 V Rechargeable
- Compatible Systems: RFID 13.56 MHz / 125 kHz
- Connection Type: Bluetooth
- Supplied with:
  - 10 x Art. RBLF-BK Low Frequency Black Fobs
  - 10 x Art. RBHF-BL High Frequency Blue Fobs
  - 5 x Art. RBHF-UL-GN High Frequency Green Fobs

Art ID.  
REBADGE-2-KIT



\ 10 x Low frequency Cloning Fobs



\ 10 x High frequency Cloning Fobs



\ 5 x High frequency Cloning Fobs

Art ID.

Description

KIT QTY.



REBADGE-2

'REBADGE 2' - Advanced RFID FOB Duplicator

1



RBLF-BK

Low Frequency KEY FOB (125KHz)  
- Suits JMA REBADGE-2 \*BLACK\*

10



RBHF-BL

High Frequency KEY FOB (13.56MHz)  
- Suits JMA REBADGE-2 \*BLUE\*

10



RBHF-UL-GN

High Frequency KEY FOB (13.56MHz) -  
ULTRALIGHT Compat.  
- Suits JMA REBADGE-2 \*GREEN\*

5





**ORIGINAL**  
**LISHI TOOLS**



**NEW**

# FORD F-150 2021+



# HU198-4

## PRODUCT DESCRIPTION

The Art. HU198-4 2-in-1 Pick and Decoder is designed for Ford 2021+ four-depth locks using HU198 "P" series key codes. It is used to pick and decode door, ignition, and trunk locks. This variant is identified by a horizontal keyway in the door handle and in-dash ignition cylinders.

## PRODUCT SPECIFICATION

- Lock Profile: HU198-4 (Ford 2021+ "P" Series)
- Tool Type: 2-in-1 Pick & Decoder (Double-Lifter)
- Compatibility: Door, Ignition & Trunk

Art ID.  
LP-HU198-4



**2-IN-1**  
**PICK & DECODER**



**XTOOL**  
AUSTRALIA

**NEW**

**BYD**

**KEY PROGRAMMING  
UPDATE**



**NEW SUPPORTED MODELS**

**SEAL**

**ATTO 3**

**SHARK**

**DOLPHIN**

**SEALION 6**

**SEALION 7**



**UPDATE BYD  
SOFTWARE  
To V26.65**





- + MORE VEHICLES
- + MORE INFORMATION
- + MORE SPEED
- + MORE CONVENIENCE

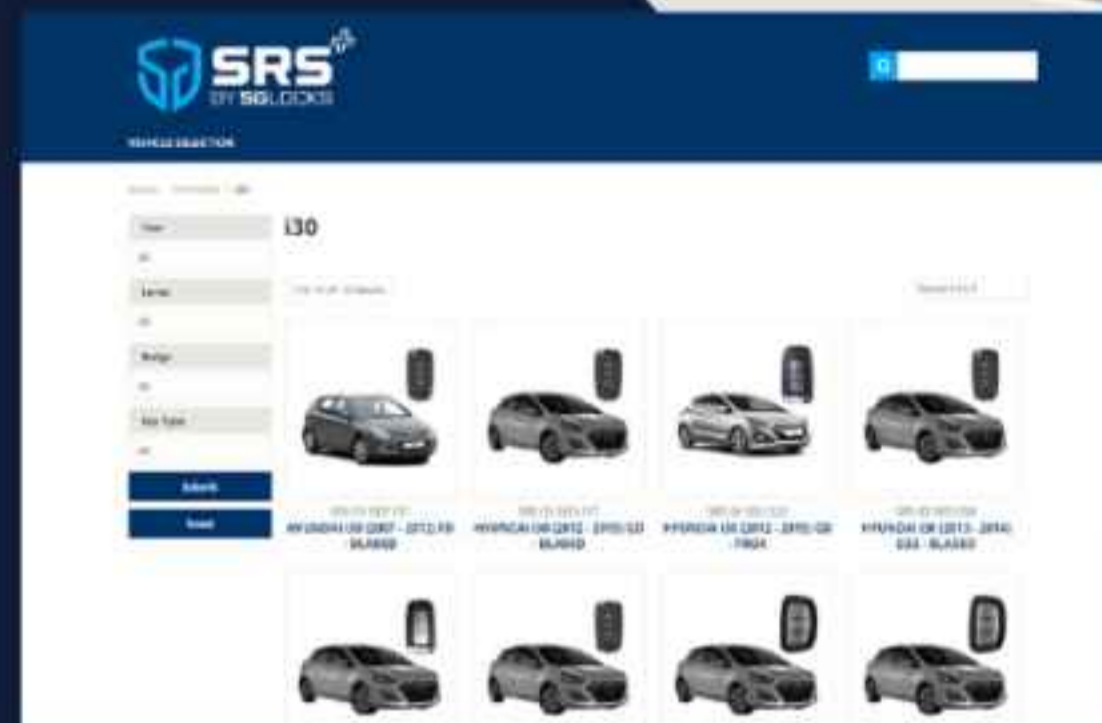
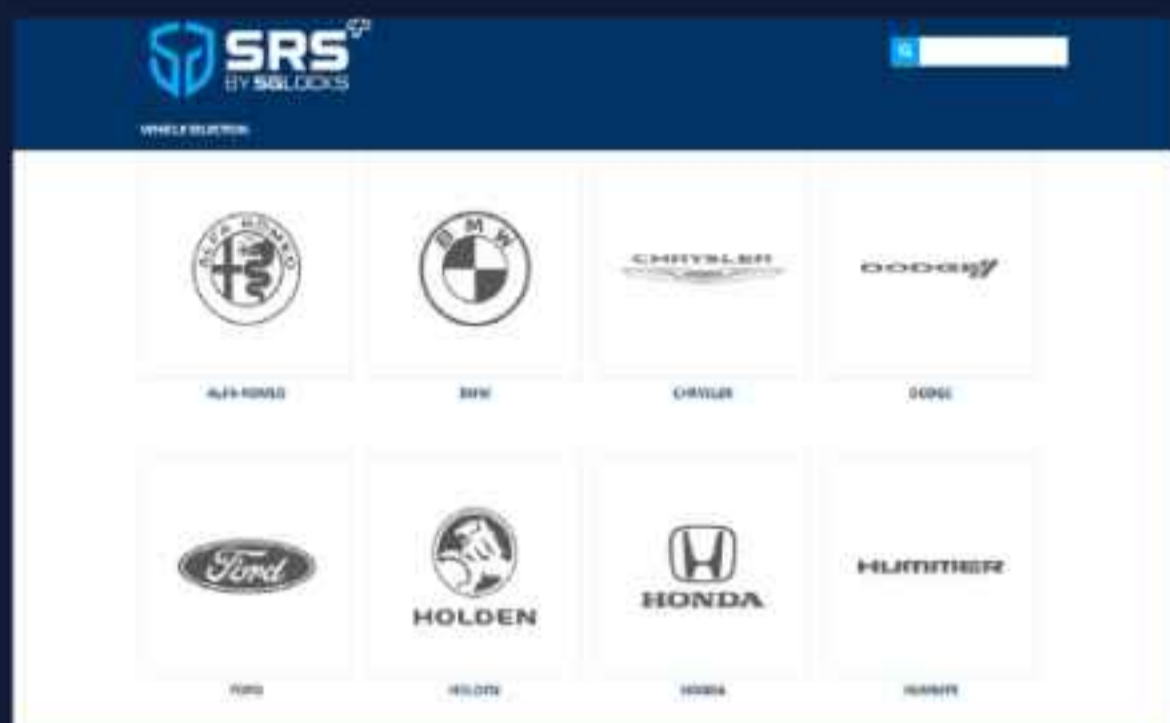

## NEW FEATURES & UPDATES

**NEW**

### Add New Vehicle

XTOOL All keys Lost, Min Number of keys, Pincode reading Pathways:

- SID4480 - BYD Atto 3 (2022 - 2025) - PROX
- SID4486 - BYD Dolphin EV (2024 - 2025) - PROX
- SID4483 - BYD Seal (2024 - 2025) - PROX
- SID4487 - BYD Seal EV (2024 - 2025) - PROX
- SID4482 - BYD Sea Lion 6 (2024 - 2025) - PROX
- SID4484 - BYD Sea Lion 7 (2024 - 2025) - PROX
- SID4488 - BYD Shark (2024 - 2025) - PROX
- SID4485 - BYD Shark 6 (2024 - 2025) - PROX
- SID4481 - BYD Dolphin (2023 - 2025) - PROX



**NEW**

### Recent Additions by User feedback:

- SID1011 - HONDA Jazz (2014 - 2020) GF - BLADED - Updated KEYDIY Remote Reference
- SID0989 - HONDA Jazz (2004 - 2008) GD - BLADED - Updated KEYDIY Remote Reference
- SID2045 - TOYOTA Hiace (2010 - 2014) KDH - BLADED - User Submitted Alternative KEYDIY Remote Reference
- SID1328 - HYUNDAI iLoad (2015 - 2018) TQ3-V SERIES II - BLADED - User Submitted Alternative KEYDIY Remote Reference and XTOOL Remote Programming Pathway

**NEW**

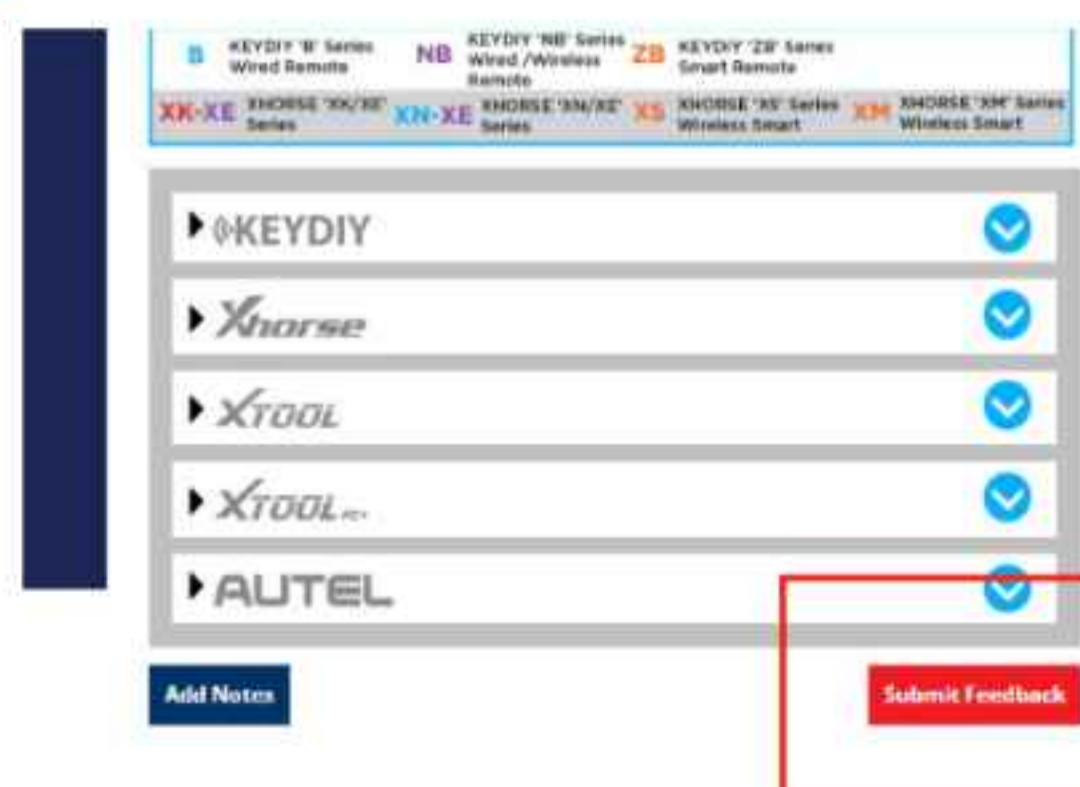

## Submit Feedback

**New SUBMIT FEEDBACK Button**  
**Submit Feedback - GET REWARDED**

**What it does**

Report a different remote reference, Programming pathway or successful solution when our suggestion wasn't quite right.

**What you get**

After validation, we'll send you a replacement KEYDIY or XHORSE remote for your stock!



**FREE**



**"Less Pain at the Pump"**



**PROMO 1** SPEND OVER **\$990.00\***  
ON

[sglocks.com.au](http://sglocks.com.au)

In the one order



**PROMO 2** SPEND OVER **\$1790.00\***  
ON

[sglocks.com.au](http://sglocks.com.au)

In the one order



**PROMO 3** SPEND OVER **\$2490.00\***  
ON

[sglocks.com.au](http://sglocks.com.au)

In the one order



**PROMO 4** SPEND OVER **\$3890.00\***  
ON

[sglocks.com.au](http://sglocks.com.au)

In the one order



Powered by



\*APRIL- MAY Promo" valid until 31 May 2026 or whilst stocks last.

\* Free Promotion item is only valid for online orders \* Pricing shown excludes GST pricing as of 12/04/2026 and is subject to change. For most accurate pricing please check the sglocks website. For more information please see [www.sglocks.com.au/page/7/promo-terms-and-conditions](http://www.sglocks.com.au/page/7/promo-terms-and-conditions) or talk to your sales representative.



**Head Office**  
PH : 02 9352 0600  
FAX: 02 9748 0566  
E-MAIL: [sales@siepergroup.com](mailto:sales@siepergroup.com)



**Your Sales Managers:**

**Colin McFarland**  
02 9352 0600  
0491 445 005

**Matt Hardwick**  
07 2142 5080  
0437 770 576

**Ian York**  
08 6383 7553  
0472 698 398

**Ross Berryman**  
03 4232 3656  
0407 551 786

**David Clohesy**  
08 7094 4849  
0492 090 558

**NZ Toll Free**  
0800 00 15 98